

L-#1  
13" H.  
19" W.  
TRANSVERSE

L-#2  
15 1/2" H.  
61" W.  
24" D.

L-#3  
11 1/2" H.  
41" W.  
24" D.

CUSTOMER APPROVED BY:

VEHICLE TYPE: CREW CARRIER	CHASSIS: FREIGHTLINER M2
VIEW: STREETSIDE	BODY MAT'L: ALUMINUM
SCALE: NTS	BODY LENGTH: 178"
DRAWN BY: NRW	APPROVED BY:
DATE: 11/24/2014	BODY STYLE:
DWG NO.: SANBERNARDINOCREW	REVISION:

**Maintainer Custom Bodies, Inc.**  
 909 South East Street  
 Rock Rapids, IA 51246  
 (800) 843-4288 Toll Free  
 (712) 472-4725 Phone

PROPOSAL FOR: COUNTY OF SAN BERNARDINO, CALIFORNIA

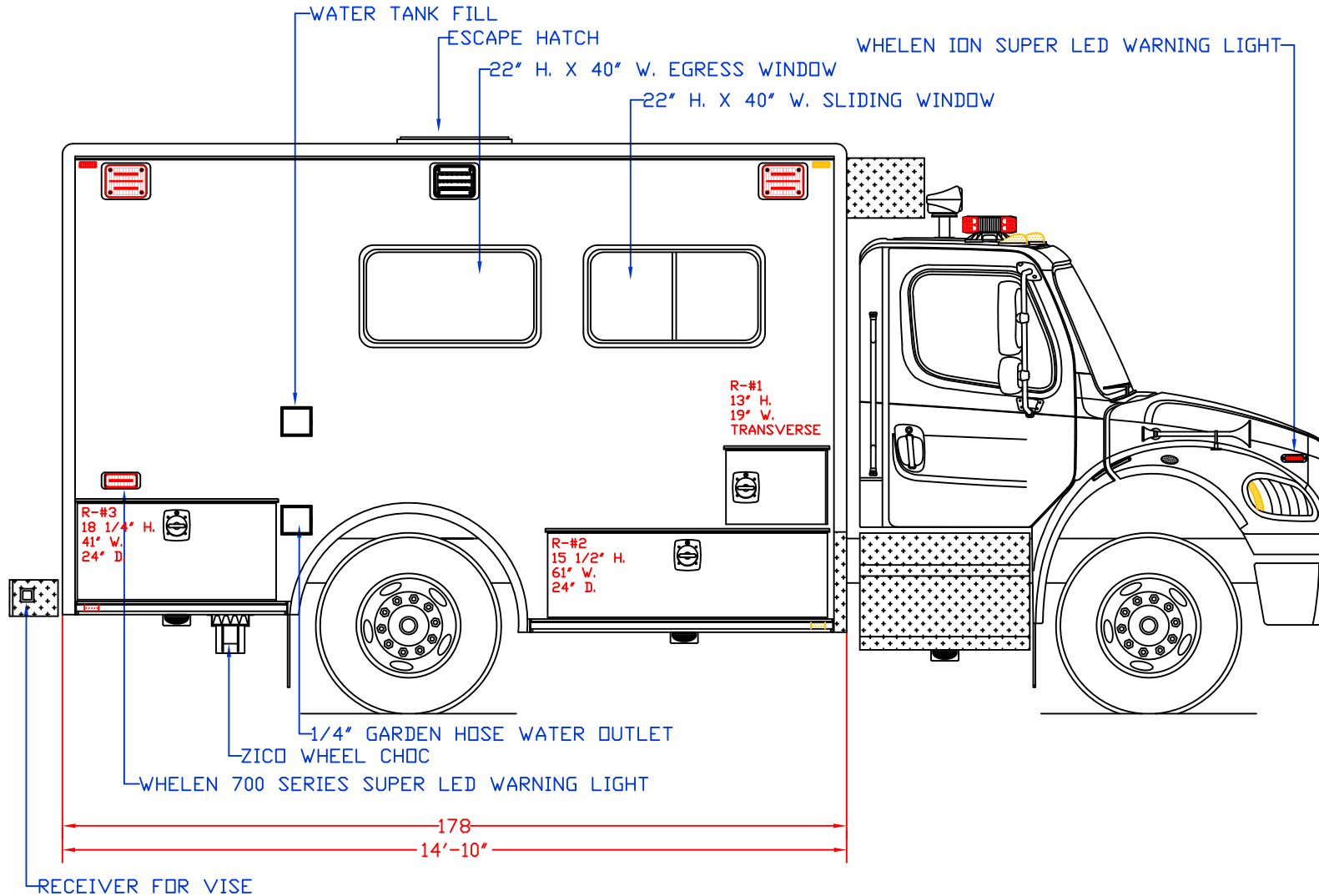

CUSTOMER APPROVED BY:

VEHICLE TYPE: CREW CARRIER  
 VIEW: CURBSIDE  
 SCALE: NTS  
 DRAWN BY: NRW  
 DATE: 11/24/2014  
 DWG NO.: SANBERNARDINOCREW

CHASSIS: FREIGHTLINER M2  
 BODY MAT'L: ALUMINUM  
 BODY LENGTH: 178"  
 APPROVED BY:  
 BODY STYLE:  
 REVISION:



**Maintainer Custom Bodies, Inc.**  
 909 South East Street (800) 843-4288 Toll Free  
 Rock Rapids, IA 51246 (712) 472-4725 Phone

PROPOSAL FOR: COUNTY OF SAN BERNARDINO, CALIFORNIA

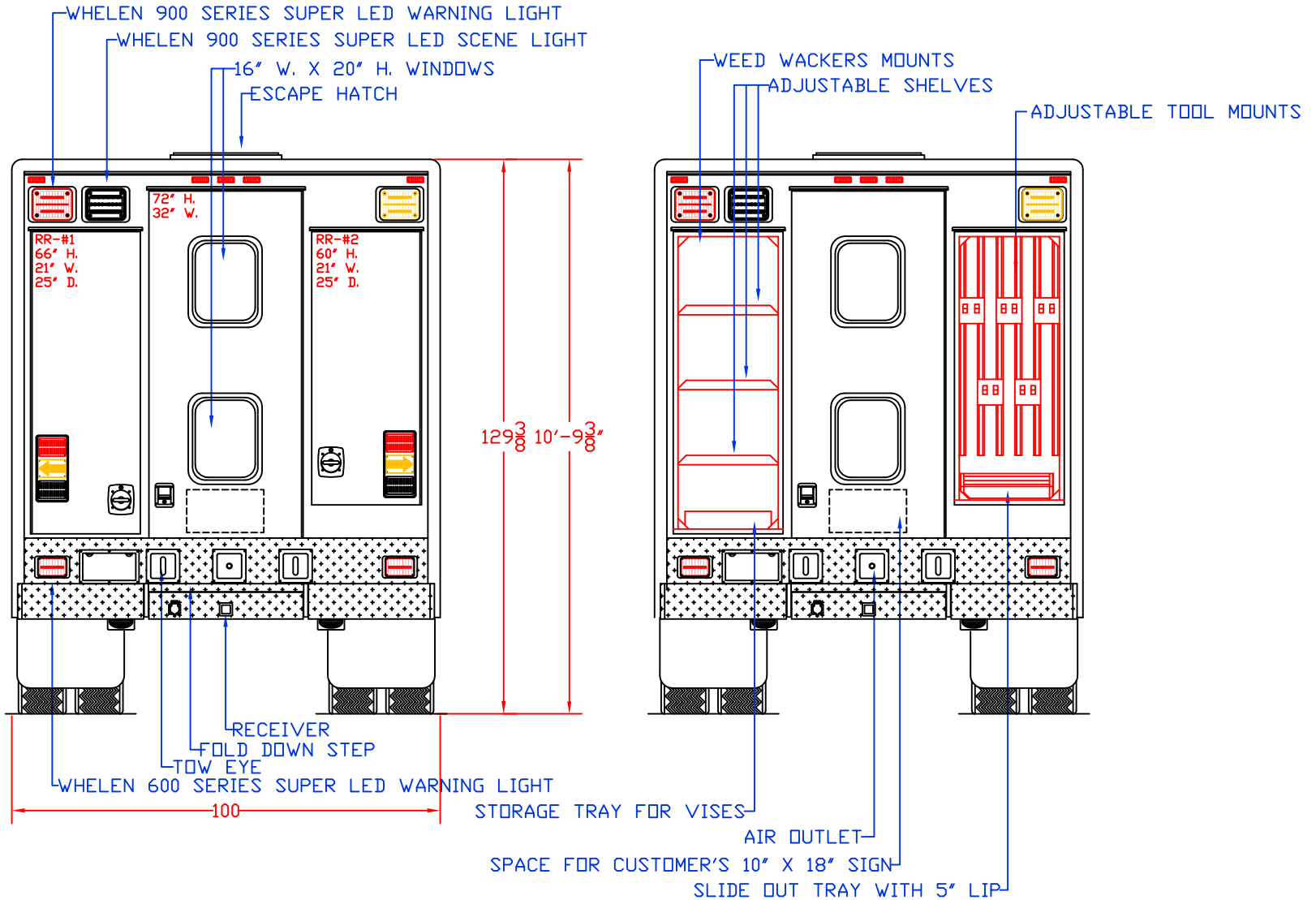

**Maintainer Custom Bodies, Inc.**  
 909 South East Street  
 Rock Rapids, IA 51246  
 (800) 843-4288 Toll Free  
 (712) 472-4725 Phone



PROPOSAL FOR: COUNTY OF SAN BERNARDINO, CALIFORNIA

<b>CUSTOMER APPROVED BY:</b>	
VEHICLE TYPE: CREW CARRIER	CHASSIS: FREIGHTLINER M2
VIEW: REAR & REAR COMPARTMENT LAYOUT	BODY MAT'L: ALUMINUM
SCALE: NTS	BODY LENGTH: 178"
DRAWN BY: NRW	APPROVED BY:
DATE: 11/24/2014	BODY STYLE:
DWG NO.: SANBERNARDINOCREW	REVISION:

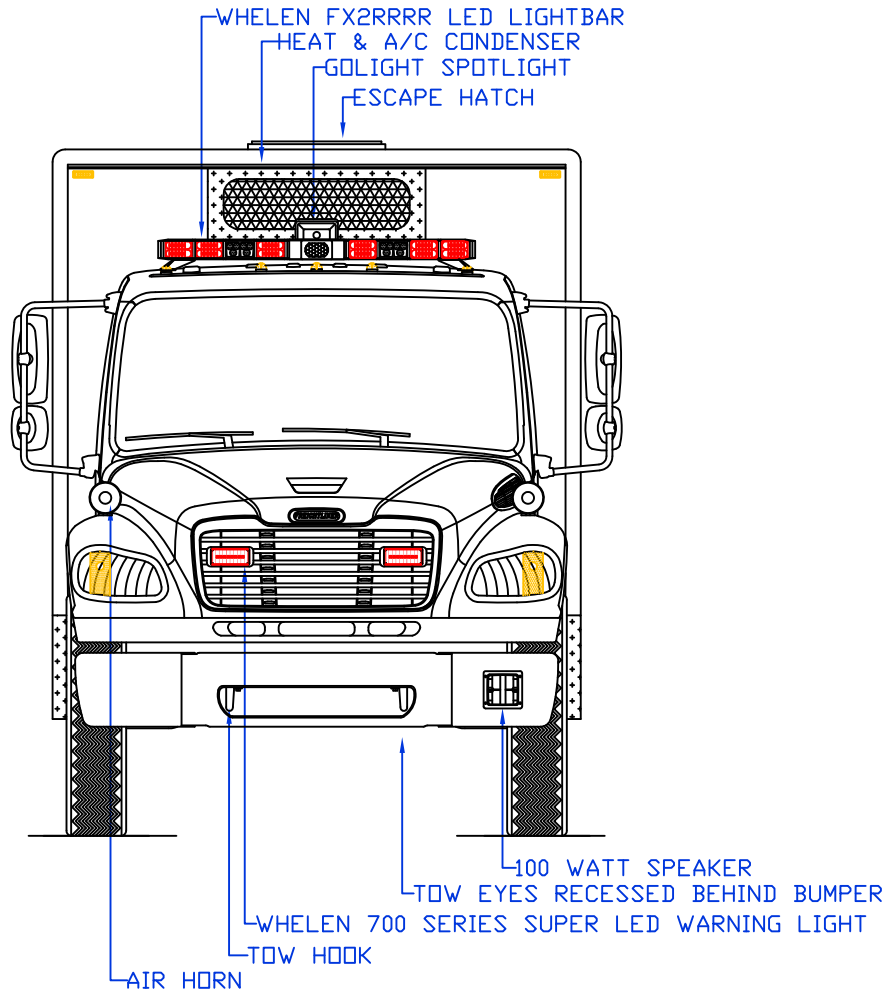

# Maintainer Custom Bodies, Inc.



909 South East Street  
 Rock Rapids, IA 51246

(800) 843-4288 Toll Free  
 (712) 472-4725 Phone

CUSTOMER APPROVED BY:

VEHICLE TYPE: CREW CARRIER	CHASSIS: FREIGHTLINER M2
VIEW: FRONT	BODY MAT'L: ALUMINUM
SCALE: NTS	BODY LENGTH: 178"
DRAWN BY: NRW	APPROVED BY:
DATE: 11/24/2014	BODY STYLE:
DWG NO.: SANBERNARDINOCREW	REVISION:

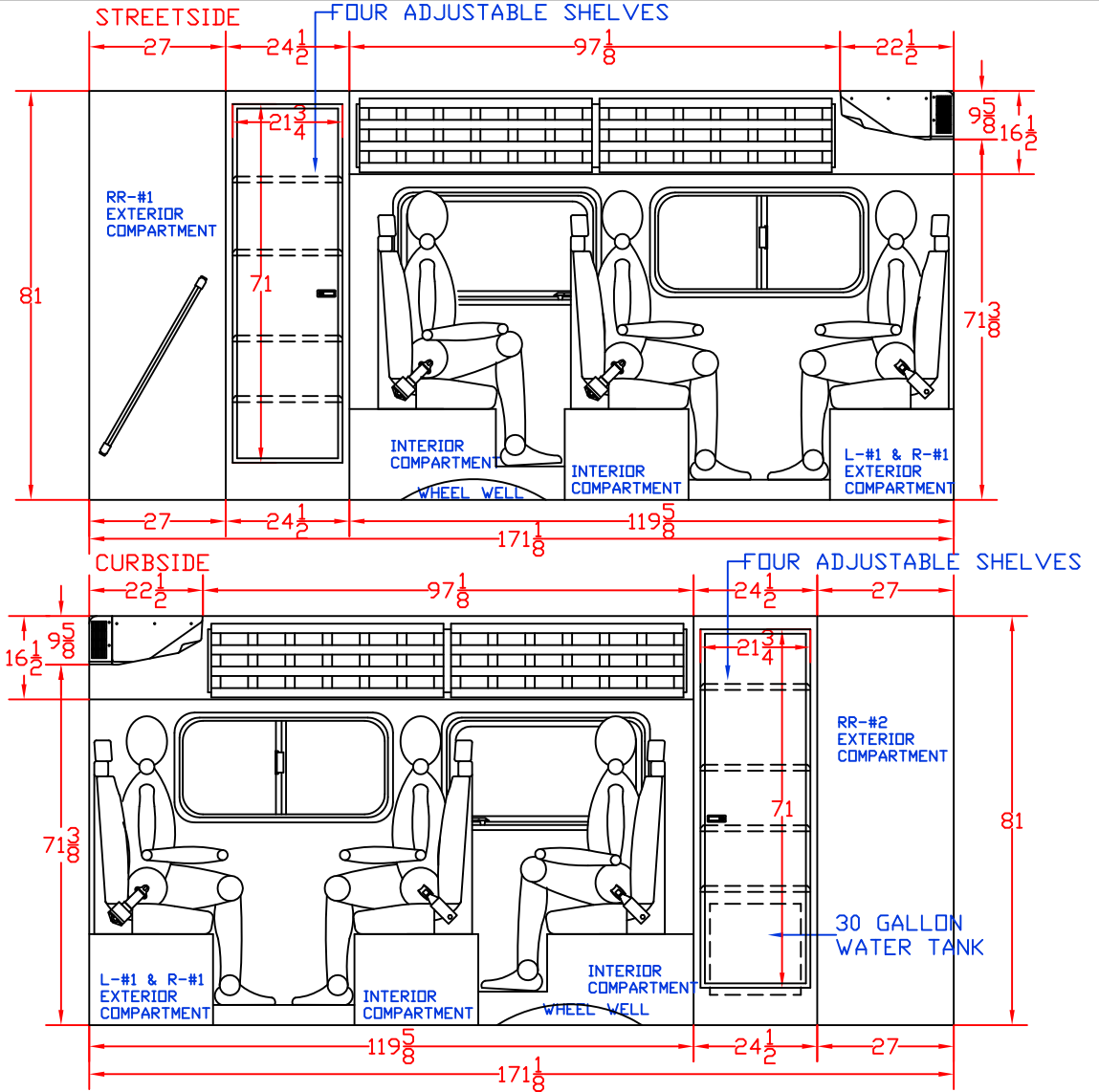
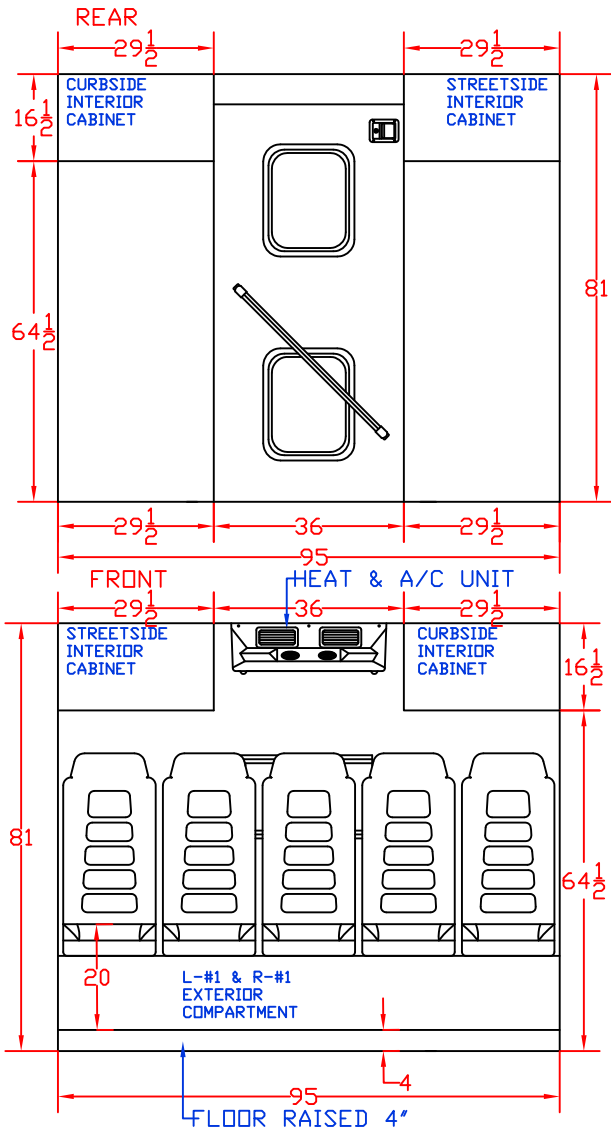

**Maintainer Custom Bodies, Inc.**  
 909 South East Street  
 Rock Rapids, IA 51246  
 (800) 843-4288 Toll Free  
 (712) 472-4725 Phone

<b>CUSTOMER APPROVED BY:</b>	
VEHICLE TYPE: CREW CARRIER	CHASSIS: FREIGHTLINER M2
VIEW: CURBSIDE	BODY MAT'L: ALUMINUM
SCALE: NTS	BODY LENGTH: 178"
DRAWN BY: NRW	APPROVED BY:
DATE: 11/24/2014	BODY STYLE:
DWG NO.: SANBERNARDINOCREW	REVISION:

PROPOSAL FOR: COUNTY OF SAN BERNARDINO, CALIFORNIA

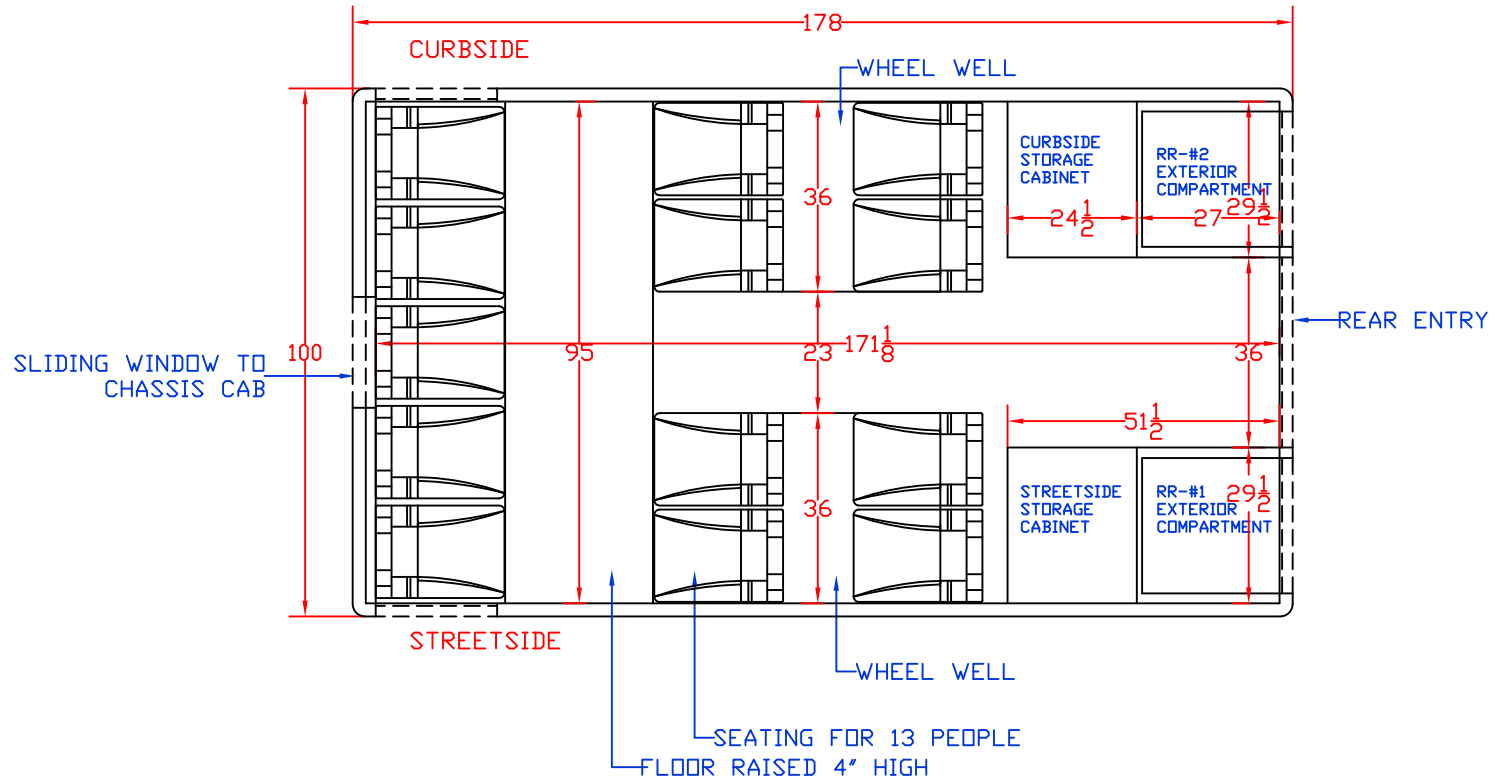

**Maintainer Custom Bodies, Inc.**  
 909 South East Street (800) 843-4288 Toll Free  
 Rock Rapids, IA 51246 (712) 472-4725 Phone

PROPOSAL FOR: COUNTY OF SAN BERNARDINO, CALIFORNIA

<b>CUSTOMER APPROVED BY:</b>	
VEHICLE TYPE: CREW CARRIER	CHASSIS: FREIGHTLINER M2
VIEW: TOP	BODY MAT'L: ALUMINUM
SCALE: NTS	BODY LENGTH: 178"
DRAWN BY: NRW	APPROVED BY:
DATE: 11/24/2014	BODY STYLE:
DWG NO.: SANBERNARDINOCREW	REVISION:

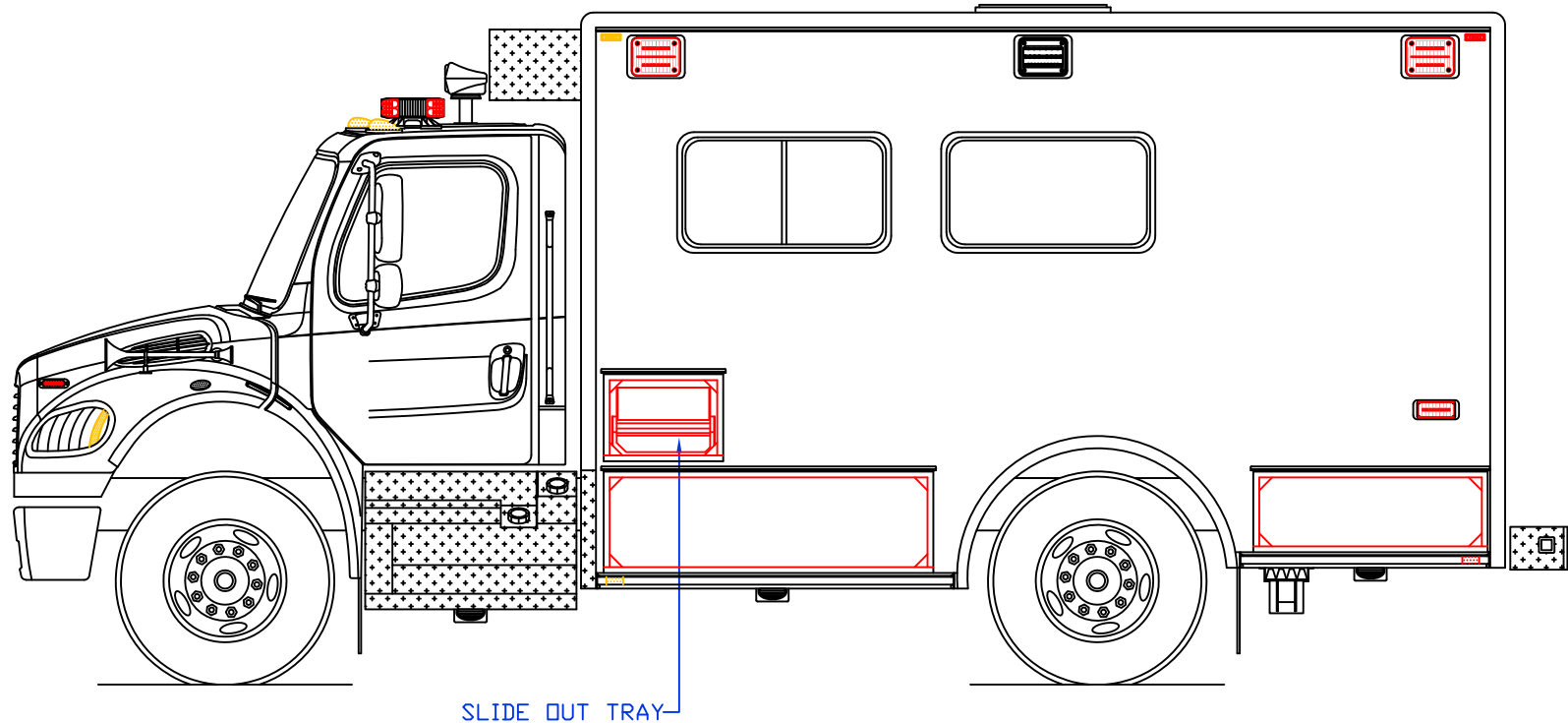

SLIDE OUT TRAY

CUSTOMER APPROVED BY:

VEHICLE TYPE: CREW CARRIER

VIEW: STREETSIDE COMPARTMENT LAYOUT

SCALE: NTS

DRAWN BY: NRW

DATE: 11/24/2014

DWG NO.: SANBERNARDINOCREW

CHASSIS: FREIGHTLINER M2

BODY MAT'L: ALUMINUM

BODY LENGTH: 178"

APPROVED BY:

BODY STYLE:

REVISION:



**Maintainer** Custom Bodies, Inc.

909 South East Street  
Rock Rapids, IA 51246

(800) 843-4288 Toll Free  
(712) 472-4725 Phone

PROPOSAL FOR: COUNTY OF SAN BERNARDINO, CALIFORNIA

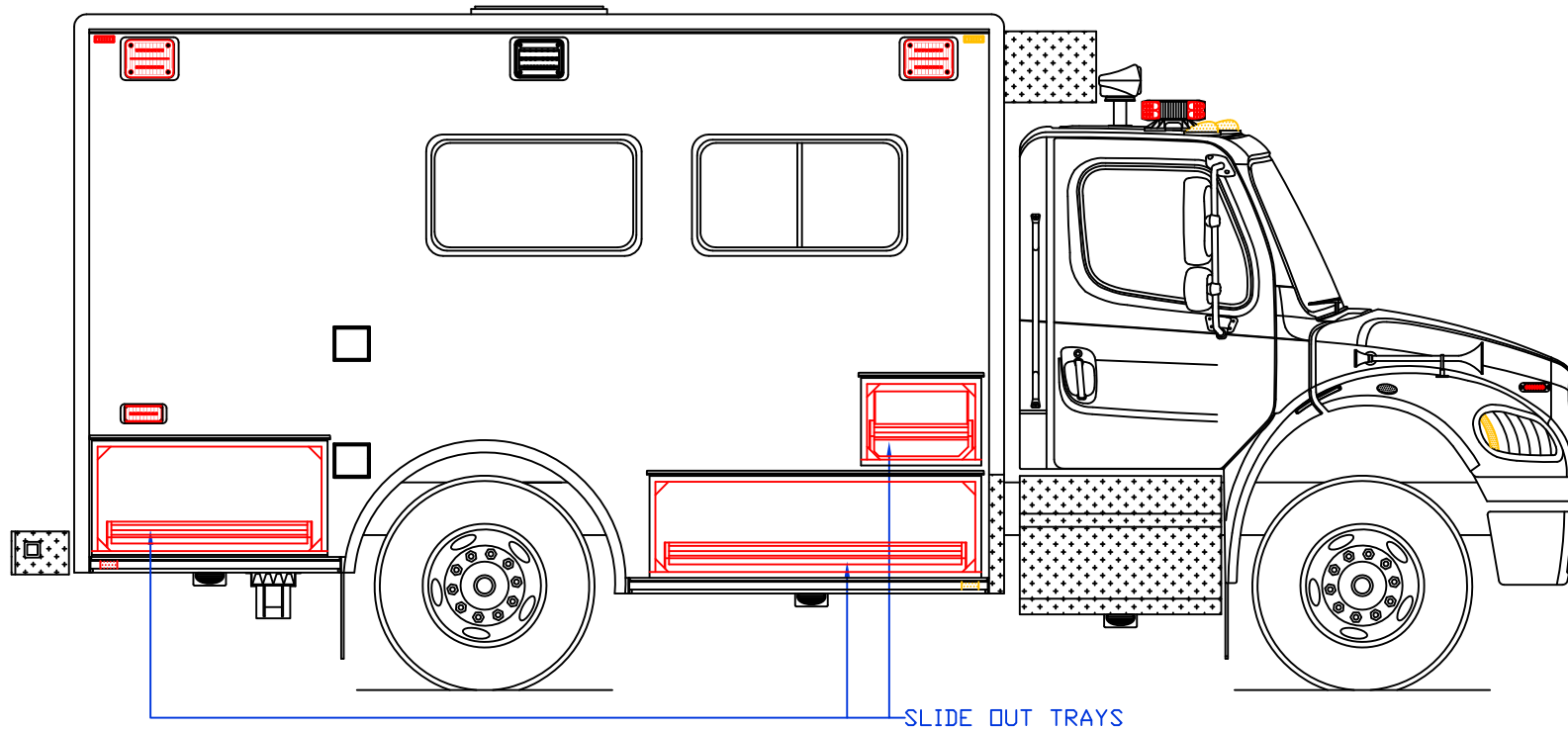

# Maintainer Custom Bodies, Inc.

909 South East Street  
Rock Rapids, IA 51246

(800) 843-4288 Toll Free  
(712) 472-4725 Phone



CUSTOMER APPROVED BY: \_\_\_\_\_

VEHICLE TYPE: CREW CARRIER  
VIEW: CURBSIDE COMPARTMENT LAYOUT  
SCALE: NTS  
DRAWN BY: NRW  
DATE: 11/24/2014  
DWG NO.: SANBERNARDINOCREW

CHASSIS: FREIGHTLINER M2  
BODY MAT'L: ALUMINUM  
BODY LENGTH: 178"  
APPROVED BY:  
BODY STYLE:  
REVISION:

PROPOSAL FOR: COUNTY OF SAN BERNARDINO, CALIFORNIA